

# 30/40/60 V Automotive-Grade P-Channel MOSFET

AEC-Q101 qualified with 175°C junction temperature



PANJIT's advanced P-channel MOSFETs are engineered to minimize  $R_{DS(ON)}$  while maximizing avalanche ruggedness and space efficiency. With AEC-Q101 qualification and a high junction temperature of 175°C, they are an ideal choice for automotive design engineers looking to simplify circuitry and enhance performance. PANJIT's P-channel MOSFETs help reduce the complexity of power circuit design and are available in a wide range of packages, including SOT-23, SOT23 6L-1, DFN2020BW-6L, DFN3333-8L, DFN5060-8L, TO-252AA, TO-263AB, and TO-263-7L.

## ► Key Features

- P-channel enhancement mode logic level MOSFETs
- 100% unclamped inductive switching (UIS) tested
- Low  $R_{DS(ON)}$  to minimize conduction losses
- 175°C operating junction temperature
- AEC-Q101 qualified and PPAP capable
- Package with low thermal resistance

## ► Typical Load Switch

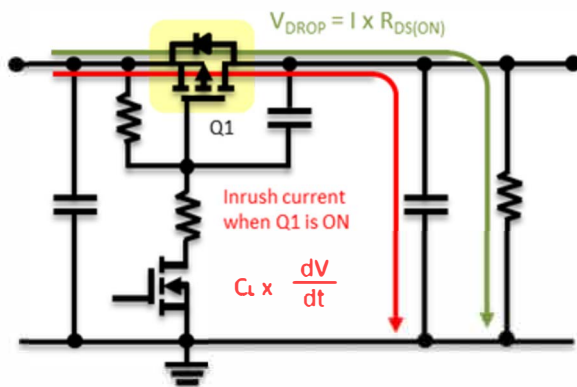

## ► Maximum Safe Operating Area

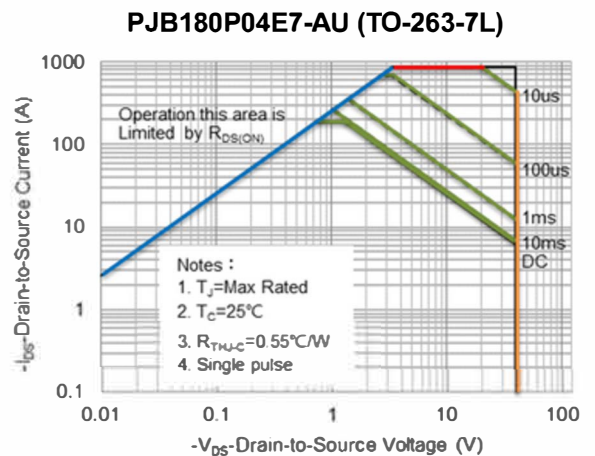



- On-state resistance limit
- Pulse current limit
- Max. pulse power dissipation limit
- Drain-source voltage limit





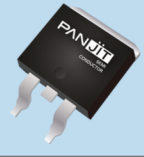
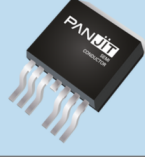

## ➤ Target Applications

- Power management function
- Reverse polarity protection
- Battery power equipment
- Primary 12/24 V systems
- LED lighting
- Infotainment
- Telematics
- ADAS
- Solenoid and motor drivers
- Brushed DC motors
- Electronic steering
- DC fan

## ➤ Products

Series	$V_{DS}$	$V_{GS}$	$V_{GS(th)}$ Max.	$R_{DS(ON)}$ @10 V Typ.	$R_{DS(ON)}$ @4.5 V Typ.	DFN3333-8L	DFN5060-8L	TO-252AA	TO-263AB	TO-263-7L
	V	V	V	mΩ	mΩ					
-30 V with ESD Logic Level	-30	±25	-1.8	15	24	PJQ4439EP-AU	PJQ5439E-AU	PJD40P03E-AU		
				12	20	PJQ4437EP-AU	PJQ5437E-AU	PJD45P03E-AU		
				9.7	15	PJQ4435EP-AU	PJQ5435E-AU	PJD55P03E-AU		
				6.7	10	PJQ4433EP-AU	PJQ5433E-AU	PJD70P03E-AU		
				5.1	8	PJQ4431EP-AU	PJQ5431E-AU	PJD90P03E-AU		
-40 V Logic Level	-40	±25	-1.8	34	50	PJQ4459EP-AU*	PJQ5459E-AU*	PJD20P04E-AU*		
				21	32	PJQ4457P-AU*	PJQ5457-AU*	PJD25P04-AU*		
				14	21	PJQ4455P-AU	PJQ5455-AU*	PJD46P04-AU*		
				9.3	13	PJQ4453EP-AU	PJQ5453E-AU	PJD60P04E-AU		
				7.8	11	PJQ4451EP-AU	PJQ5451E-AU	PJD75P04E-AU		
				4.8	7	-	PJQ5449E-AU	PJD95P04E-AU		
				4	5.4	-	PJQ5447E-AU	PJD100P04E-AU	PJB120P04E-AU	PJB140P04E7-AU
				3.2	4.7	-	-	-	PJB160P04E-AU	PJB180P04E7-AU

Series	$V_{DS}$	$V_{GS}$	$V_{GS(th)}$ Max.	$R_{DS(ON)}$ @10 V Typ.	$R_{DS(ON)}$ @4.5 V Typ.	SOT-23 / SOT-23 6L-1	DFN2020BW-6L	DFN3333-8L	DFN5060-8L	TO-252AA
	V	V	V	mΩ	mΩ					
-60 V Logic Level	-60	±20	-1.8	145	190	PJA3461S-AU				
						PJS64613-AU				
				64	85	PJS64611-AU	PJQ24611AW-AU	PJQ44611AP-AU		
				47	62	-	PJQ24609AW-AU	PJQ44609AP-AU	PJQ54609A-AU	
				32	43	-	-	PJQ44607AP-AU	PJQ54607A-AU	PJD30P06A-AU
				21	28	-	-	PJQ44605AP-AU	PJQ54605A-AU	PJD40P06A-AU
				14	20	-	-	-	PJQ54603A-AU	PJD50P06A-AU
10.5	15	-	-	-	PJQ54601A-AU	PJD60P06A-AU				

\*Under development with samples available - Package Limitation